

SPECIFICATIONS FOR NICHIA **BLUE** LED

MODEL : **NSPB510AS**

NICHIA CORPORATION

1. SPECIFICATIONS

(1) Absolute Maximum Ratings

(Ta=25°C)

| Item | Symbol | Absolute Maximum Rating | Unit |
|-----------------------|--------|-------------------------|------|
| Forward Current | IF | 35 | mA |
| Pulse Forward Current | IFP | 110 | mA |
| Reverse Voltage | VR | 5 | V |
| Power Dissipation | PD | 123 | mW |
| Operating Temperature | Topr | -30 ~ + 85 | °C |
| Storage Temperature | Tstg | -40 ~ +100 | °C |
| Soldering Temperature | Tsld | 265°C for 10sec. | |

IFP Conditions : Pulse Width ≤ 10msec. and Duty ≤ 1/10

(2) Initial Electrical/Optical Characteristics

(Ta=25°C)

| Item | Symbol | Condition | Typ. | Max. | Unit | |
|--------------------------|--------|-----------|---------------|-------|------|---|
| Forward Voltage | VF | IF=20[mA] | (3.2) | 3.5 | V | |
| Reverse Current | IR | VR= 5[V] | - | 50 | μA | |
| Luminous Intensity | Iv | IF=20[mA] | (4700)(new)*1 | - | mcd | |
| Luminous Intensity | Iv | IF=20[mA] | (5600)(old)*2 | - | mcd | |
| Chromaticity Coordinate* | x | - | IF=20[mA] | 0.133 | - | - |
| | y | - | IF=20[mA] | 0.075 | - | - |

* Please refer to CIE 1931 chromaticity diagram.

*1 Change previously listed luminous intensity values (see *2) to luminous intensity values traceable to the current national standards on and after January 1, 2009.

(In accordance with CIE 127:2007)

(3) Ranking

(Ta=25°C)

| Item | Symbol | Condition | Min. | Max. | Unit | |
|----------------------------|--------|-----------|-----------|------|------|-----|
| Luminous Intensity (new)*1 | Rank X | Iv | IF=20[mA] | 6020 | 8380 | mcd |
| | Rank W | Iv | IF=20[mA] | 4190 | 6020 | mcd |
| | Rank V | Iv | IF=20[mA] | 3010 | 4190 | mcd |

(Ta=25°C)

| Item | Symbol | Condition | Min. | Max. | Unit | |
|----------------------------|--------|-----------|-----------|------|-------|-----|
| Luminous Intensity (old)*2 | Rank X | Iv | IF=20[mA] | 7200 | 10000 | mcd |
| | Rank W | Iv | IF=20[mA] | 5000 | 7200 | mcd |
| | Rank V | Iv | IF=20[mA] | 3600 | 5000 | mcd |

* Luminous Intensity Measurement allowance is ± 10%.

Color Rank (If=20mA, Ta=25°C)

| | Rank W | | | |
|---|--------|------|------|------|
| x | 0.11 | 0.11 | 0.15 | 0.15 |
| y | 0.04 | 0.10 | 0.10 | 0.04 |

* Color Coordinates Measurement allowance is ± 0.01 .

* Basically, a shipment shall consist of the LEDs of a combination of the above ranks.

The percentage of each rank in the shipment shall be determined by Nichia.

2.INITIAL OPTICAL/ELECTRICAL CHARACTERISTICS

Please refer to "CHARACTERISTICS" on the following pages.

3.OUTLINE DIMENSIONS AND MATERIALS

Please refer to "OUTLINE DIMENSIONS" on the following page.

Material as follows ; Resin : Epoxy Resin
 Leadframe : Ag Plating Copper Alloy

4.PACKAGING

· The LEDs are packed in cardboard boxes after packaging in anti-electrostatic bags.

Please refer to "PACKING" on the following pages.

The label on the minimum packing unit shows ; Part Number, Lot Number, Ranking, Quantity

- In order to protect the LEDs from mechanical shock, we pack them in cardboard boxes for transportation.
- The LEDs may be damaged if the boxes are dropped or receive a strong impact against them, so precautions must be taken to prevent any damage.
- The boxes are not water resistant and therefore must be kept away from water and moisture.
- When the LEDs are transported, we recommend that you use the same packing method as Nichia.

5.LOT NUMBER

The first six digits number shows **lot number**.

The lot number is composed of the following characters;

○□×××× - △■

○ - Year (7 for 2007, 8 for 2008)

□ - Month (1 for Jan., 9 for Sep., A for Oct., B for Nov.)

×××× - Nichia's Product Number

△ - Ranking by Color Coordinates

■ - Ranking by Luminous Intensity

6.RELIABILITY

(1) TEST ITEMS AND RESULTS

| Test Item | Standard Test Method | Test Conditions | Note | Number of Damaged |
|---------------------------------------------------|--------------------------|---------------------------------------------------------------|----------------------|-------------------|
| Resistance to Soldering Heat | JEITA ED-4701 300 302 | Tsld=260 ± 5°C, 10sec. 3mm from the base of the epoxy bulb | 1 time | 0/50 |
| Solderability | JEITA ED-4701 300 303 | Tsld=235 ± 5°C, 5sec. (using flux) | 1 time over 95% | 0/50 |
| Temperature Cycle | JEITA ED-4701 100 105 | -40°C ~ 25°C ~ 100°C ~ 25°C 30min. 5min. 30min. 5min. | 100 cycles | 0/50 |
| Moisture Resistance Cyclic | JEITA ED-4701 200 203 | 25°C ~ 65°C ~ -10°C 90%RH 24hrs./1cycle | 10 cycles | 0/50 |
| Terminal Strength (bending test) | JEITA ED-4701 400 401 | Load 5N (0.5kgf) 0° ~ 90° ~ 0° bend 2 times | Nonnoticeable damage | 0/50 |
| Terminal Strength (pull test) | JEITA ED-4701 400 401 | Load 10N (1kgf) 10 ± 1 sec. | Nonnoticeable damage | 0/50 |
| High Temperature Storage | JEITA ED-4701 200 201 | Ta=100°C | 1000hrs. | 0/50 |
| Temperature Humidity Storage | JEITA ED-4701 100 103 | Ta=60°C, RH=90% | 1000hrs. | 0/50 |
| Low Temperature Storage | JEITA ED-4701 200 202 | Ta=-40°C | 1000hrs. | 0/50 |
| Steady State Operating Life | | Ta=25°C, IF=35mA | 1000hrs. | 0/50 |
| Steady State Operating Life of High Humidity Heat | | 60°C, RH=90%, IF=20mA | 500hrs. | 0/50 |
| Steady State Operating Life of Low Temperature | | Ta=-30°C, IF=20mA | 1000hrs. | 0/50 |

(2) CRITERIA FOR JUDGING DAMAGE

| Item | Symbol | Test Conditions | Criteria for Judgement | |
|--------------------|----------------|----------------------|------------------------|----------------|
| | | | Min. | Max. |
| Forward Voltage | V _F | I _F =20mA | - | U.S.L.*) × 1.1 |
| Reverse Current | I _R | V _R =5V | - | U.S.L.*) × 2.0 |
| Luminous Intensity | I _V | I _F =20mA | L.S.L.***) × 0.7 | - |

*) U.S.L. : Upper Standard Level

**) L.S.L. : Lower Standard Level

7. CAUTIONS

(1) Lead Forming

- When forming leads, the leads should be bent at a point at least 3mm from the base of the epoxy bulb. Do not use the base of the leadframe as a fulcrum during lead forming.
- Lead forming should be done before soldering.
- Do not apply any bending stress to the base of the lead. The stress to the base may damage the LED's characteristics or it may break the LEDs.
- When mounting the LEDs onto a printed circuit board, the holes on the circuit board should be exactly aligned with the leads of the LEDs. If the LEDs are mounted with stress at the leads, it causes deterioration of the epoxy resin and this will degrade the LEDs.

(2) Storage

- The LEDs should be stored at 30°C or less and 70%RH or less after being shipped from Nichia and the storage life limits are 3 months. If the LEDs are stored for 3 months or more, they can be stored for a year in a sealed container with a nitrogen atmosphere and moisture absorbent material.
- Nichia LED leadframes are silver plated copper alloy. The silver surface may be affected by environments which contain corrosive substances. Please avoid conditions which may cause the LED to corrode, tarnish or discolor. This corrosion or discoloration may cause difficulty during soldering operations. It is recommended that the LEDs be used as soon as possible.
- Please avoid rapid transitions in ambient temperature, especially, in high humidity environments where condensation can occur.

(3) Recommended circuit

- In designing a circuit, the current through each LED must not exceed the absolute maximum rating specified for each LED. It is recommended to use Circuit B which regulates the current flowing through each LED. In the meanwhile, when driving LEDs with a constant voltage in Circuit A, the current through the LEDs may vary due to the variation in forward voltage (V_F) of the LEDs. In the worst case, some LED may be subjected to stresses in excess of the absolute maximum rating.

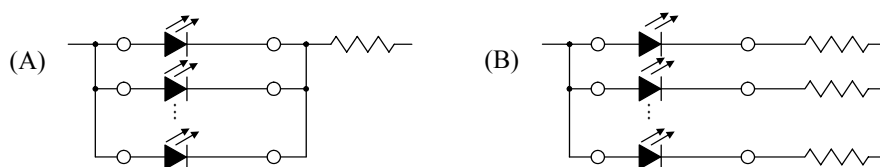

- This product should be operated in forward bias. A driving circuit must be designed so that the product is not subjected to either forward or reverse voltage while it is off. In particular, if a reverse voltage is continuously applied to the product, such operation can cause migration resulting in LED damage.

(4) Static Electricity

- Static electricity or surge voltage damages the LEDs.
It is recommended that a wrist band or an anti-electrostatic glove be used when handling the LEDs.
- All devices, equipment and machinery must be properly grounded. It is recommended that precautions be taken against surge voltage to the equipment that mounts the LEDs.
- When inspecting the final products in which LEDs were assembled, it is recommended to check whether the assembled LEDs are damaged by static electricity or not. It is easy to find static-damaged LEDs by a light-on test or a VF test at a lower current (below 1mA is recommended).
- Damaged LEDs will show some unusual characteristics such as the leak current remarkably increases, the forward voltage becomes lower, or the LEDs do not light at the low current.

Criteria : (VF > 2.0V at IF=0.5mA)

(5) Soldering Conditions

- Nichia LED leadframes are silver plated copper alloy. This substance has a low thermal coefficient (easily conducts heat). Careful attention should be paid during soldering.
- Solder the LED no closer than 3mm from the base of the epoxy bulb. Soldering beyond the base of the tie bar is recommended.
- Recommended soldering conditions

| Dip Soldering | | Hand Soldering | |
|-------------------------|-----------------------------------------------------|----------------|------------------------------------------------------|
| Pre-Heat | 120°C Max. | Temperature | 350°C Max. |
| Pre-Heat Time | 60 seconds Max. | Soldering Time | 3 seconds Max. |
| Solder Bath Temperature | 260°C Max. | Position | No closer than 3 mm from the base of the epoxy bulb. |
| Dipping Time | 10 seconds Max. | | |
| Dipping Position | No lower than 3 mm from the base of the epoxy bulb. | | |

- Although the recommended soldering conditions are specified in the above table, dip or hand soldering at the lowest possible temperature is desirable for the LEDs.
- A rapid-rate process is not recommended for cooling the LEDs down from the peak temperature.
- Dip soldering should not be done more than one time.
- Hand soldering should not be done more than one time.
- Do not apply any stress to the lead particularly when heated.
- The LEDs must not be repositioned after soldering.
- After soldering the LEDs, the epoxy bulb should be protected from mechanical shock or vibration until the LEDs return to room temperature.
- Direct soldering onto a PC board should be avoided. Mechanical stress to the resin may be caused from warping of the PC board or from the clinching and cutting of the leadframes. When it is absolutely necessary, the LEDs may be mounted in this fashion but the User will assume responsibility for any problems. Direct soldering should only be done after testing has confirmed that no damage, such as wire bond failure or resin deterioration, will occur. Nichia's LEDs should not be soldered directly to double sided PC boards because the heat will deteriorate the epoxy resin.
- When it is necessary to clamp the LEDs to prevent soldering failure, it is important to minimize the mechanical stress on the LEDs.
- Cut the LED leadframes at room temperature. Cutting the leadframes at high temperatures may cause failure of the LEDs.

(6) Heat Generation

- Thermal design of the end product is of paramount importance. Please consider the heat generation of the LED when making the system design. The coefficient of temperature increase per input electric power is affected by the thermal resistance of the circuit board and density of LED placement on the board, as well as other components. It is necessary to avoid intense heat generation and operate within the maximum ratings given in this specification.
- The operating current should be decided after considering the ambient maximum temperature of LEDs.

(7) Cleaning

- It is recommended that isopropyl alcohol be used as a solvent for cleaning the LEDs. When using other solvents, it should be confirmed beforehand whether the solvents will dissolve the resin or not. Freon solvents should not be used to clean the LEDs because of worldwide regulations.
- Do not clean the LEDs by the ultrasonic. When it is absolutely necessary, the influence of ultrasonic cleaning on the LEDs depends on factors such as ultrasonic power and the assembled condition. Before cleaning, a pre-test should be done to confirm whether any damage to the LEDs will occur.

(8) Safety Guideline for Human Eyes

- The International Electrical Commission (IEC) published in 2006 IEC 62471:2006 *Photobiological safety of lamps and lamp systems* which includes LEDs within its scope. Meanwhile LEDs were removed from the scope of the IEC 60825-1:2007 laser safety standard, the 2001 edition of which included LED sources within its scope. However, keep in mind that some countries and regions have adopted standards based on the IEC laser safety standard IEC 60825-1:2001 which includes LEDs within its scope.

Following IEC 62471:2006, most of Nichia LEDs can be classified as belonging to either Exempt Group or Risk Group 1. Optical characteristics of a LED such as output power, spectrum and light distribution are factors that affect the risk group determination of the LED. Especially a high-power LED, that emits light containing blue wavelengths, may be in Risk Group 2.

Great care should be taken when viewing directly the LED driven at high current or the LED with optical instruments, which may greatly increase the hazard to your eyes.

(9) Others

- NSPB500AS complies with RoHS Directive.
- Care must be taken to ensure that the reverse voltage will not exceed the absolute maximum rating when using the LEDs with matrix drive.
- Flashing lights have been known to cause discomfort in people; you can prevent this by taking precautions during use. Also, people should be cautious when using equipment that has had LEDs incorporated into it.
- The LEDs described in this brochure are intended to be used for ordinary electronic equipment (such as office equipment, communications equipment, measurement instruments and household appliances). Consult Nichia's sales staff in advance for information on the applications in which exceptional quality and reliability are required, particularly when the failure or malfunction of the LEDs may directly jeopardize life or health (such as for airplanes, aerospace, submersible repeaters, nuclear reactor control systems, automobiles, traffic control equipment, life support systems and safety devices).
- User shall not reverse engineer by disassembling or analysis of the LEDs without having prior written consent from Nichia. When defective LEDs are found, the User shall inform Nichia directly before disassembling or analysis.
- The formal specifications must be exchanged and signed by both parties before large volume purchase begins.
- The appearance and specifications of the product may be modified for improvement without notice.

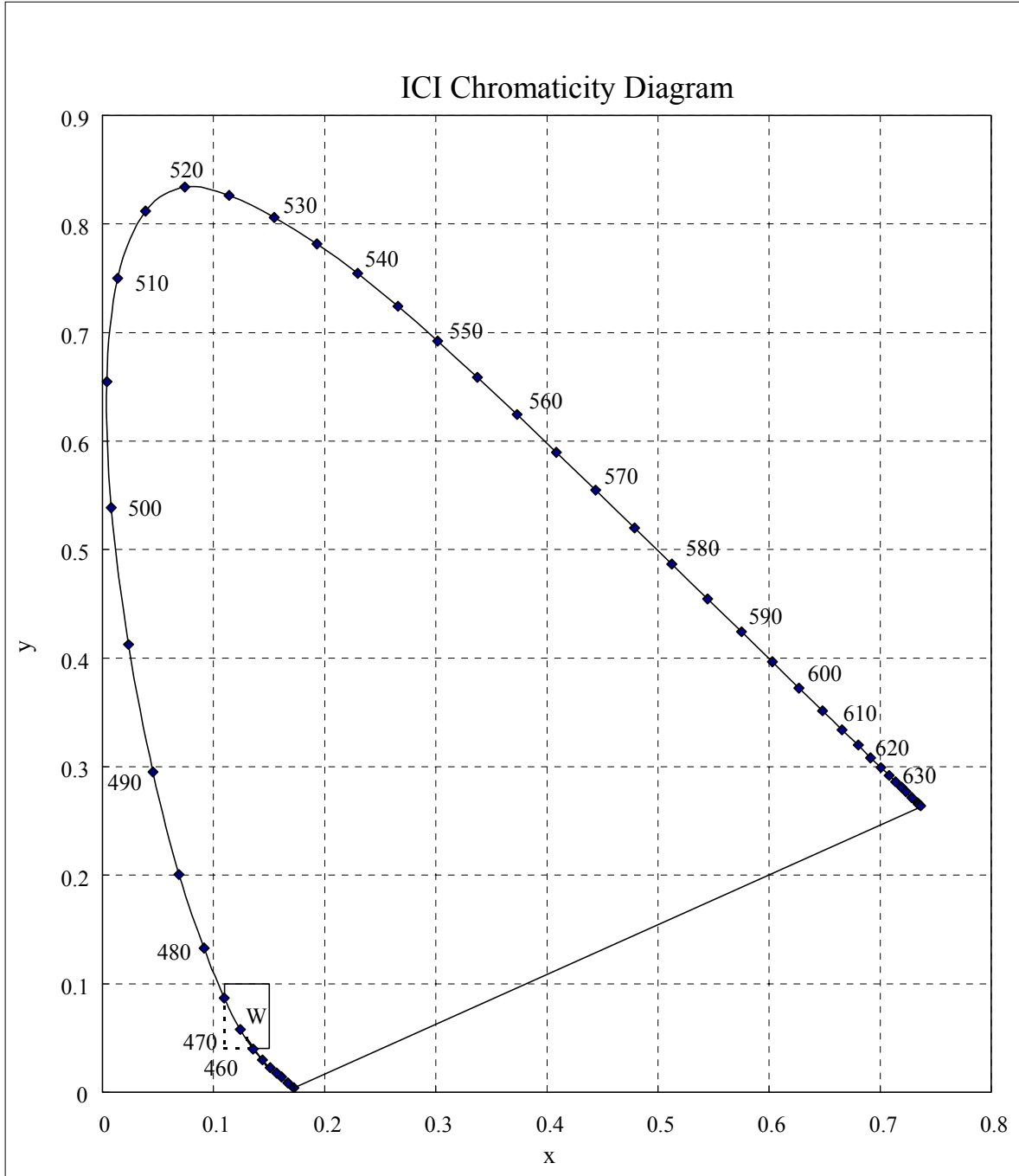

* Color Coordinates Measurement allowance is ± 0.01 .

■ Forward Voltage vs. Forward Current

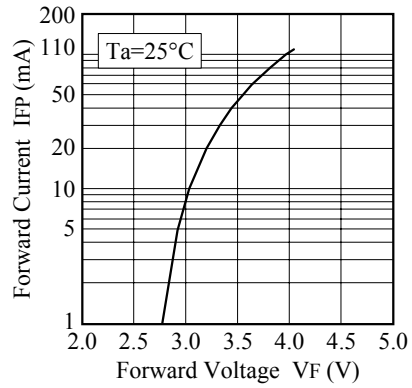

■ Forward Current vs. Relative Luminosity

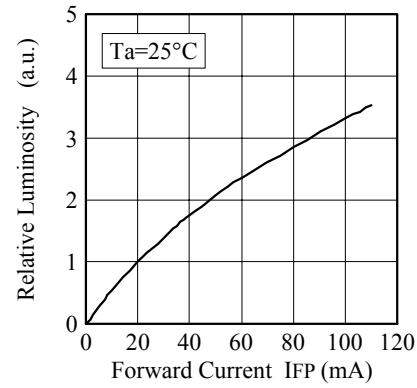

■ Duty Ratio vs. Allowable Forward Current

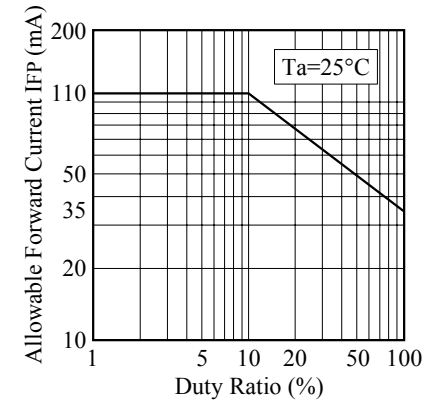

■ Ambient Temperature vs. Forward Voltage

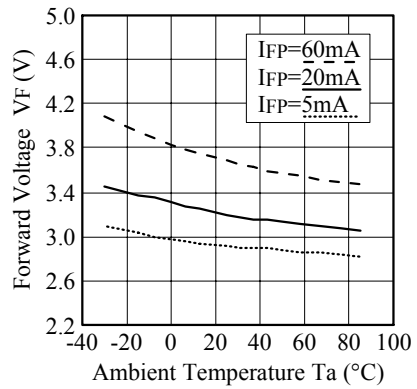

■ Ambient Temperature vs. Relative Luminosity

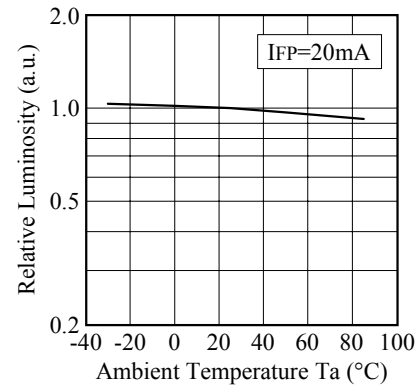

■ Ambient Temperature vs. Allowable Forward Current

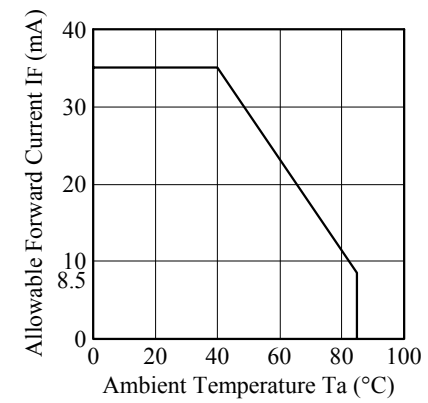

| | | |
|---------------------------|-------|-----------------|
| NICHIA CORPORATION | Model | NSPBxxxx |
| | Title | CHARACTERISTICS |
| | No. | 070528765631 |

■ Forward Current vs. Chromaticity Coordinate (λ_D)

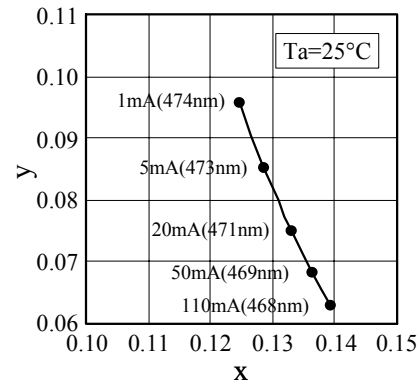

■ Spectrum

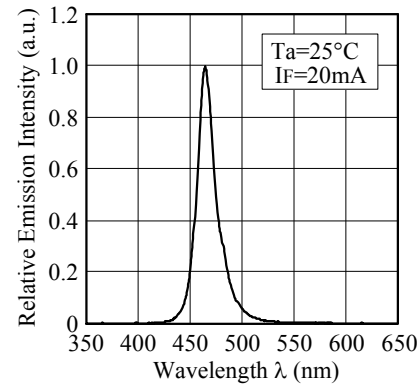

■ Forward Current vs. Dominant Wavelength

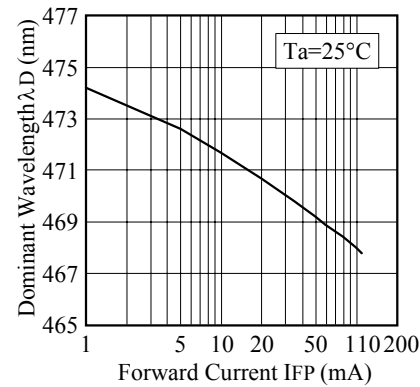

■ Ambient Temperature vs. Dominant Wavelength

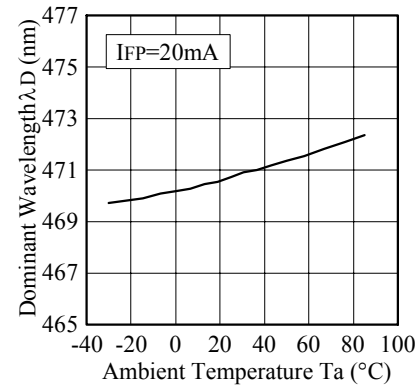

■ Directivity

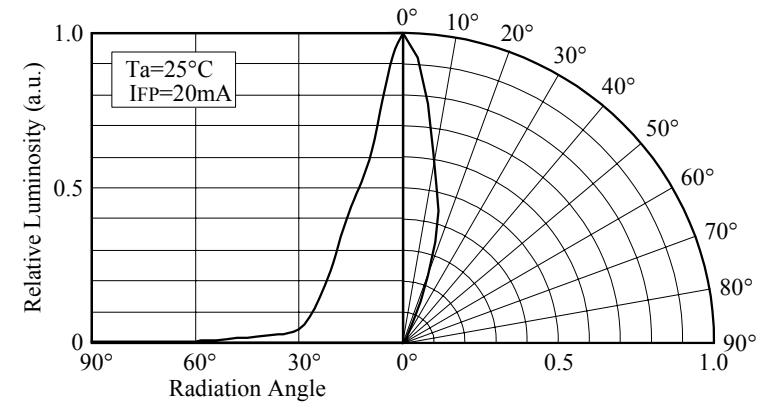

| | | |
|---------------------------|-------|-----------------|
| NICHIA CORPORATION | Model | NSPB510AS |
| | Title | CHARACTERISTICS |
| | No. | 071018702081 |

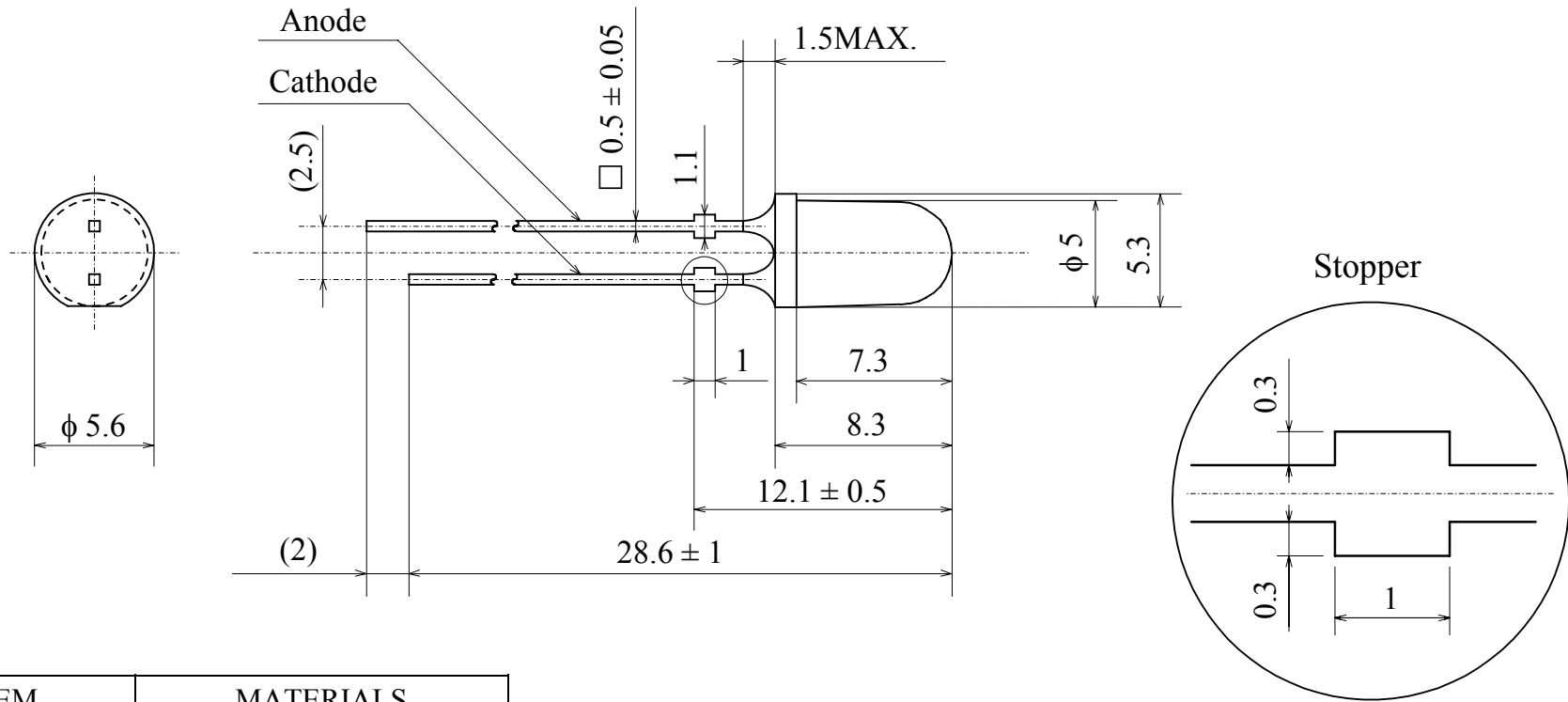

| ITEM | MATERIALS |
|------------|-------------------------|
| RESIN | Epoxy Resin |
| LEAD FRAME | Ag Plating Copper Alloy |

Remark:

Please note that the bare copper alloy showing at the cut end of the lead frame may be corroded under certain conditions. LEDs have some sharp edges and points, particularly lead frames. Please handle with care so as to avoid injuries.

| | | | |
|--------------------|-------|--------------------|---------------|
| NICHIA CORPORATION | Model | NSPB510AS | Unit mm |
| | Title | OUTLINE DIMENSIONS | |
| | No. | 071018702091 | Allow ±0.2 |

